

P5-16...R40-17

Model: S18

en Assembly and Operating Instructions

SMI tubular drives for ZIP systems

Important information for:

- Fitters / • Electricians / • Users

Please forward accordingly!

These instructions must be kept safe for future reference.

2010 300 893 0d 22/02/2024

Becker-Antriebe GmbH
Friedrich-Ebert-Straße 2-4
35764 Sinn/Germany
info@becker-antriebe.com
www.becker-antriebe.com



BECKER
for you. forever.

Table of contents

General	3
Warranty	3
Safety instructions	4
Instructions for the user	4
Instructions for installation and commissioning.....	4
Intended use	6
Assembling and disassembling the plug-in connecting cable.....	6
Assembly	7
Setting the limit positions using the programming unit.....	9
Deleting the limit positions using the programming unit.....	11
Setting the limit positions with Auto-install (for ZIP applications with heavy end strip).....	12
Obstacle detection (for ZIP applications with heavy end strip).....	13
Activating/deactivating the additional fabric untensioning function with the programming unit.....	13
Information for the electrician	13
Disposal	13
Maintenance	14
Technical data dia. 35	14
Technical data dia. 45	14
What to do if...?	15
Sample wiring diagram	16
Assignment table for the SMI tubular drives.....	17
Declaration of conformity	18

General

These tubular drives are high-quality products with the following features:

- Optimised for vertical ZIP applications
- Installation without stops possible (from extended point to retracted point)
- Automatic detection of limit positions thanks to intelligent electronic system with stop systems
- The limit positions do not have to be reset: Changes in the shading solution are accommodated automatically when using stop systems.
- Simple to set the limit position by pressing a button on the programming unit
- Suitable for vertical sun protection
- Considerably reduced stop load, and thus considerably reduced fabric load
- Activate/deactivate the fabric untensioning function
- Left or right hand installation
- Several drives can be operated in parallel
- Smooth operation of the system and the drive increases the service life
- For plug-in connecting cable

Please follow these Assembly and Operating Instructions when installing and setting up the device.



The date of manufacture comes from the first four digits of the serial number.

The numbers 1 and 2 indicate the year and the numbers 3 and 4 indicate the calendar week.

Example: 34th calendar week in 2020

Ser. No.:	2034XXXXX
-----------	-----------

Explanation of pictograms

	CAUTION	CAUTION indicates a hazardous situation which, if not avoided, could result in injury.
	ATTENTION	ATTENTION indicates measures that must be taken to avoid damage to property.
		Denotes user tips and other useful information.

Warranty

Structural modifications and incorrect installation which are not in accordance with these and our other instructions can result in serious injuries, e.g., crushing of limbs. Therefore, structural modifications may only be carried out with our prior approval and strictly in accordance with our instructions, particularly the information contained in these Assembly and Operating Instructions. Any further processing of the products which does not comply with their intended use is not permitted.

The end product manufacturer and fitter have to ensure that all the relevant current statutory, official and, in particular, EMC regulations are adhered to during utilisation of our products, especially with regard to end product manufacture, installation and customer advice.

Safety instructions

The following safety instructions and warnings are intended to avert hazards and to prevent property damage and personal injury.

Instructions for the user

General information

- The drive must be disconnected from its power source during cleaning and maintenance and when replacing parts.
- All work, including maintenance and cleaning, on electrical installations as well as other system parts must always be performed by trained technicians, in particular qualified electricians.
- Children from the age of 8 years and persons with reduced physical, sensory or mental capabilities or lack of experience and/or knowledge may use these devices, provided they are supervised or have been instructed in the safe use of the device, and have understood the hazards involved. Children must not play with the device.
- Systems have to be checked regularly by authorised specialists for wear and damage.
- Always put damaged systems out of operation immediately until they are repaired by an authorised specialist.
- Do not operate equipment if people or objects are within the danger zone.
- Observe the danger zone of the equipment during operation.
- Ensure that there is adequate clearance (at least 40 cm) between moving parts and adjacent objects.



Caution

Safety instructions for avoiding serious injuries.

- **Crushing or shearing points must be avoided or protected.**

Instructions for installation and commissioning

General information

- Observe the safety instructions in EN 60335-2-97. Please note that this list of safety instructions is not exhaustive, since it would be impossible for the standard to include all sources of danger. For example, the design of the operated product, the way the drive works in the situation it is installed in or even the way the end product is mounted in the end user's place of use cannot be taken into consideration by the drive manufacturer.
If any questions or uncertainties regarding the safety instructions contained in the standard arise, please contact the manufacturer of the part or end product in question.
- All applicable standards and regulations for electrical installation must be complied with.
- All work, including maintenance and cleaning, on electrical installations as well as other system parts must always be performed by trained technicians, in particular qualified electricians.
- Only use spare parts, tools and accessory devices which have been approved by the drive manufacturer.
Unapproved third-party products or modifications to the system and its accessories represent a risk to your safety and the safety of others. This means that the use of unapproved third-party products, or modifications which have not been agreed with or approved by us, are prohibited. We do not accept liability for damage or injury arising from such actions.
- Position switch with OFF presetting within sight of the driven product, but away from moving parts, at a height of over 1.5 m. This must not be publicly accessible.
- Permanently mounted control devices must be positioned where they can be seen.
- Rated torque and duty cycle must be suitable for the requirements of the driven product.
Technical data - rated torque and service life can be found on the type plate of the tubular drive.
- Hazardous moving parts of the drive must be installed at a height of over 2.5 m above floor level or any other surface from which the drive can be accessed.
- To ensure safe operation of the system after commissioning, the limit positions must be correctly set/programmed in.
- Drives with a H05VV-F connecting cable may only be used indoors.
- Drives with a H05RR-F, S05RN-F or 05RN-F connecting cable may be used both indoors and outdoors.
- To connect the drive to the driven part, solely mechanical accessory components made by the drive manufacturer from the current product catalogue may be used. The components must be installed in accordance with the manufacturer's instructions.

- If the drive is used for shading solutions in a specially marked area (e.g., escape routes, hazard zones, safety areas), compliance with all applicable regulations and standards must be ensured.
- Once the drive has been installed, the fitter must mark the used tubular drive in the “Technical data” chapter and make a note of the installation position.



Caution

Safety instructions for avoiding serious injuries.

- **When electrical or electronic equipment and units are operated, certain components, e.g., the power supply unit, are live. Physical injuries or damage to property can result in the event of unauthorised interventions or failure to heed warnings.**
- **Be careful when touching the tubular drive, as it heats up during operation for technical reasons.**
- **Before installation, shut down all lines and control devices that are not essential for operation.**
- **Crushing or shearing points must be avoided or protected.**
- **When installing the drive, all-pole disconnection from the mains with a contact gap of at least 3 mm per pole must be provided (EN 60335).**
- **If the mains connecting cable is damaged, it may only be replaced by the manufacturer. If the drive has a plug-in connecting cable, it must be replaced with the same type of mains connecting cable, which is available from the drive manufacturer.**

Attention

Safety instructions for avoiding property damage.

- **Ensure that there is adequate clearance between moving parts and adjacent objects.**
- **The drive must not be carried by the mains connecting cable.**
- **All latching connections and fastening screws on the brackets must be checked to ensure that they are secure.**
- **Ensure that nothing rubs against the tubular drive, such as shading solution attachments, screws, etc.**
- **The drive must be fitted horizontally.**

Intended use

The type of tubular drive described in these instructions is intended solely for the operation of vertical ZIP systems.

It may only be used in networked systems if all the individual drives are exactly synchronised and reach the limit positions at the same time.

When mounting connection parts on the drive dia. 35 mm PXX/XX, only use screws EJOT Delta PT 40x12 WN 5454 Torx (9900 000 545 4).

For roller shutter applications, please use only the types of tubular drive designed for this purpose.

This type of tubular drive is designed for use in single systems (one drive per barrel).

The tubular drive must not be used in potentially explosive areas.

The connecting cable is not suitable for transporting the drive. Always carry the drive by the housing tube.

Other applications, uses and modifications are not permitted in order to protect the safety of the users and others, since these actions can impair the system's safety and carry the risk of personal injury and property damage. The drive manufacturer does not accept liability for damages or injury arising from such actions.

Always observe the information in these instructions when operating or repairing the system. The drive manufacturer does not accept liability for damage or injury resulting from improper usage.

Assembling and disassembling the plug-in connecting cable



Caution

The power supply to the connecting cable must be disconnected prior to assembly/disassembly.

Assembling the plug-in connecting cable

Ø35/Ø45/Ø58

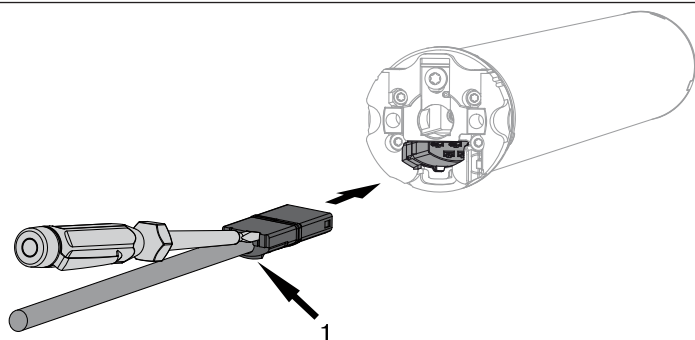

1 = locating lug

Insert the **dead** connecting cable into the drive head until the locating lug clicks into place in the drive. If necessary, use a suitable flathead screwdriver to assist with insertion. Set the screwdriver into one of the two plug grooves provided for this purpose.

Check that the cable is properly engaged.

Disassembling the plug-in connecting cable for tubular drives

Ø35

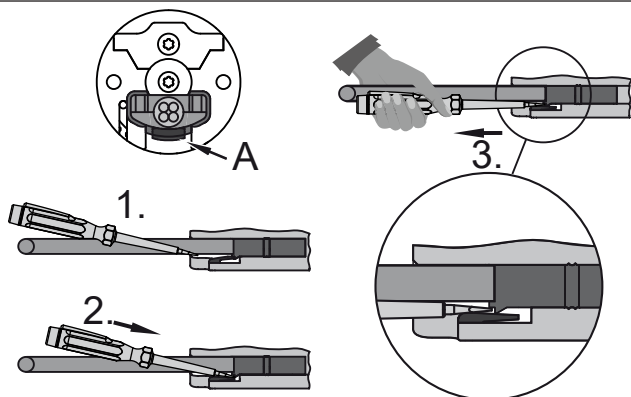

A = snap-in pin

Insert a suitable flathead screwdriver between the locating lug and the snap-in pin, so that the snap-in pin releases the locating lug from the plug.

Now you can pull out the connecting cable along with the flathead screwdriver.

Ø45/Ø58	<p>Insert a suitable flathead screwdriver right into the recess of the locating latch, so that the latch releases the locating lug from the plug.</p> <p>Now you can pull out the connecting cable along with the flat-head screwdriver.</p>
<p>A = locating latch</p>	

Assembly

Assembling the drive

Attention

To connect the drive to the driven part, solely mechanical accessory components made by the drive manufacturer from the current product catalogue may be used.

Prior to mounting, the fitter must ensure that the masonry and the system being motorised are sufficiently robust (drive torque plus weight of the shading solution).



Caution

Electrical connections may only be carried out by a qualified electrician. Prior to assembly, the power supply must be disconnected and secured. Please give the enclosed connection information to the responsible electrical contractor.

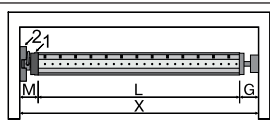

Calculate the space required at the side (M) by measuring the drive head (1) and wall bracket (2). The clear dimension of the box (X) minus the space required at the side (M) and idler (G) gives the length (L) of the barrel: $L = X - M - G$.

The space required at the side (M) varies depending on the combination of drive and wall bracket.

Then mount the wall bracket and idler. Ensure that the barrel is aligned at right angles to the wall and that sufficient axial play is allowed for the mounted system.

Assembling and disassembling the mounting pin

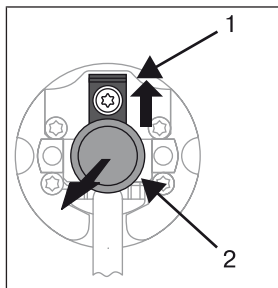

Ø45

When pushed in, the mounting pin (2) locks automatically. To undo the mounting pin (2), push the tab washer (1) upwards and pull out the mounting pin (2).

Assembling and disassembling the drive adapter

Fitting the ring onto the thrust ring

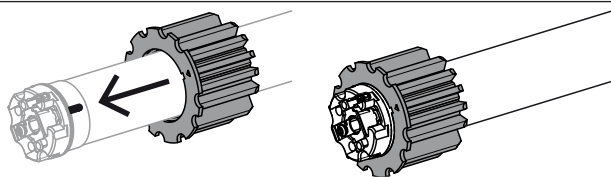

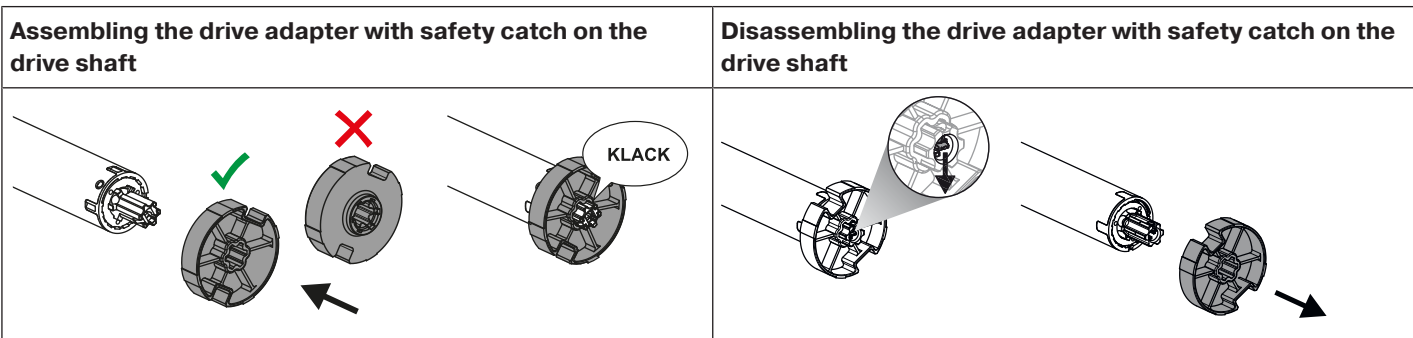

Mounting the drive in the tube

	<p>For profile shafts:</p> <p>In the case of some drive adapters, tolerances of the groove widths in different barrels can be offset by rotating the drive adapter into a different groove recess. These groove recesses have different sizes and allow the drive to fit exactly.</p>
--	--

	<p>For round shafts:</p> <p>Measure the lug of the thrust ring (X, Y). Then notch the tube on the motor side, so the lug of the thrust ring can also be pushed into the shaft. There must be no play between the lug of the thrust ring and the shaft.</p>
--	---

	<p>To ensure secure torque transmission for round shafts, we recommend screwing the drive adapter to the shaft (see the table below).</p> <p>Attention! When drilling into the barrel, never drill near the tubular drive!</p>
--	--

Size of drive [mm]	Drive adapter	Torque max. [Nm]	Fastening screws (4 units)
dia. 35-dia. 45	All	Up to 50	Self-tapping screw dia. 4.8 x 9.5 mm

We also recommend screwing the idler to the barrel.

Attention

Do not hammer the tubular drive into the tube or drop it into the barrel!

	<p>Assemble the tubular drive with the relevant ring (1) and drive adapter (2). If the ring has several grooves, select the groove which is a perfect fit and push the ring (1) onto the thrust ring.</p> <p>Insert the tubular drive with the pre-assembled ring (1) and drive adapter (2) into the tube to achieve a form fit. Ensure that the ring and drive adapter are secure in the tube.</p> <p>Mount the assembled unit comprising shaft, tubular drive and idler on the box and secure the drive with a splint or spring pin according to the type of wall bracket fixing.</p>
--	---

	<p>Lay the connecting cable</p> <p>Lay the connecting cable up to the tubular drive, and fix. The connecting cable must not project into the winding chamber. The exterior antenna, if present, must not be shortened or damaged under any circumstances and must not project into the winding space. Cover any sharp edges.</p>
--	---

Setting the limit positions using the programming unit

Intelligent installation management

Completion of installation following automatic setting of limit position "Stop"

Next time the "stop" limit position is travelled to, this position will be provisionally saved as the limit position. Once the limit position has been detected at this position 3 times in a row without any problems, it will be definitively saved. This normally takes place during regular operation.

To complete installation quickly, it is sufficient to travel to the "stop" limit position 3 times in a row from approx. 20 cm.

Limit position status indicator

A brief stopping and restarting indicates that no limit position has been set in that direction of movement.

Setting the limit positions

There are several ways to set the limit positions:

- Lower point to upper point without stops
- Lower point to upper stop
- Auto install

The limit position becomes fixed after the tubular drive has turned off **automatically** in the desired position three times.

i If the tubular drive switches off prematurely while extending/retracting, due to an obstruction, the obstruction can be cleared by extending/retracting the screen and removing the obstruction. The upper limit position can be set by extending/retracting again.

Attention

The programming unit is only designed for the commissioning, not for continuous operation.

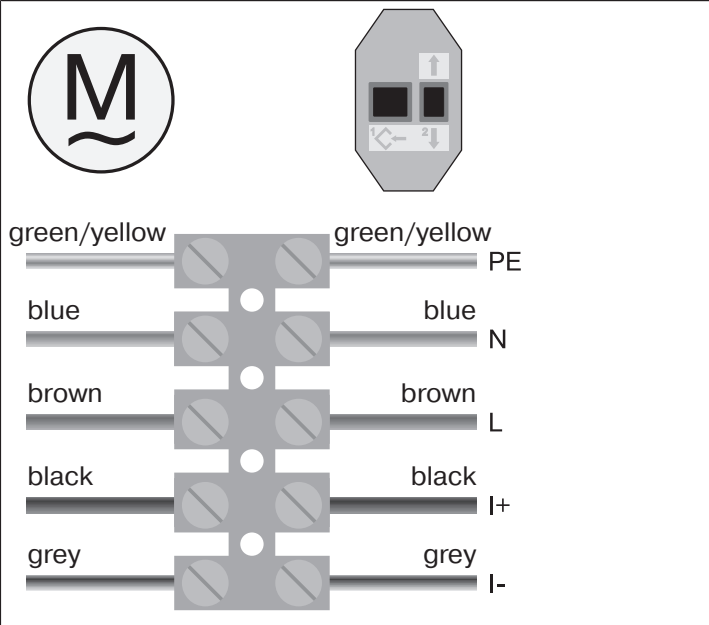
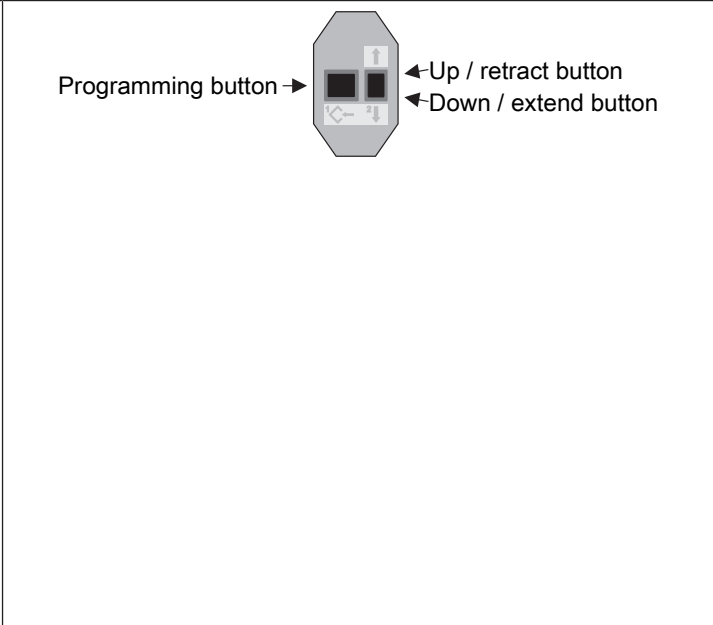
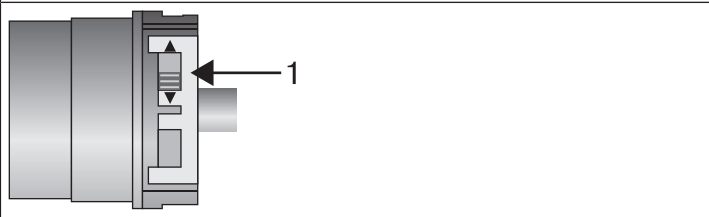
 <p>green/yellow PE</p> <p>blue N</p> <p>brown L</p> <p>black I+</p> <p>grey I-</p>	 <p>Programming button →</p> <p>← Up / retract button</p> <p>← Down / extend button</p>
 <p>1</p>	<p>1 = direction switch</p>

Connect the wires of the tubular drive to those of the same colour in the programming unit (Item No. 4935 200 034 0) and switch on the power supply.

Check the assignment of the direction of rotation before positioning the limit stops.

Press the retract or extend button.

- ▷ The shading solution runs in the desired direction

- ▶ The running direction is OK.

If the shading solution runs in the wrong direction, the running direction must be changed. Proceed as follows:

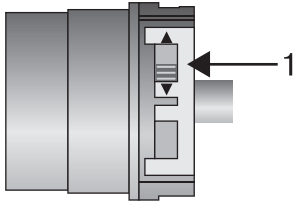

Switch the direction switch (1) to the opposite position.

- ▷ The running direction will now have changed.



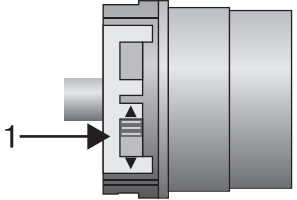

Check the running direction again.





i It is only possible to change the direction of rotation if no limit position has been set. It may be necessary to delete both limit positions in order to change the direction of rotation.

Lower point to upper point without stops with the programming unit

i There is no shading solution length adjustment with this limit position setting.

		Close to the desired lower limit position.
	(M) 1x	Press the programming button of the programming unit for 3 seconds. ▷ The tubular drive acknowledges.
		Then open to the desired upper limit position.
	(M) 1x	Press the programming button of the programming unit for 3 seconds. ▷ The tubular drive acknowledges. ▶ The limit positions are now set.

Lower point to upper stop with the programming unit







		Close to the desired lower limit position.
	(M) 1x	Press the programming button of the programming unit for 3 seconds. ▷ The tubular drive acknowledges.
		Then open as far as the permanent upper stop. ▷ The tubular drive switches off automatically. ▶ The limit positions are now set.

Deleting the limit positions using the programming unit

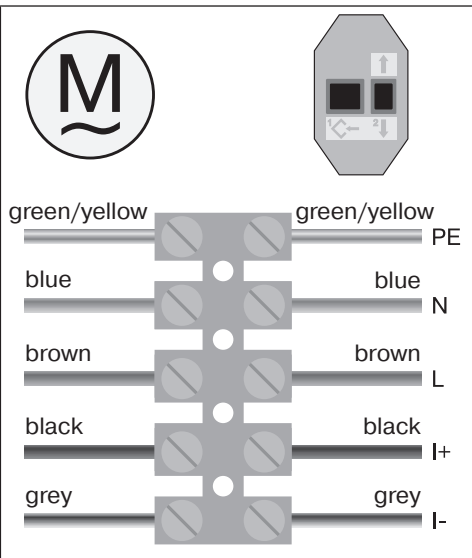
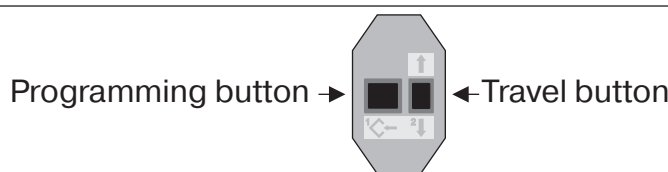
i Connect the wires of the tubular drive to those of the same colour in the programming unit and switch on the power supply.
Please pause for 1 sec after the last drive command before beginning the deletion sequence. Also leave a pause of 1 sec between the individual steps of the deletion sequence.





Deleting a limit position when 2 limit positions are programmed

i Any additional functions that have been set are retained.

	
	<p>Open/close to the limit position to be deleted.</p>
	<p>Press the programming button and keep it pressed.</p>
	<p>Then press down the travel button and keep it pressed.</p>
	<p>Now release the programming button, but continue to keep the travel button pressed.</p>
	<p>Next press the programming button again.</p> <ul style="list-style-type: none"> ▶ The tubular drive acknowledges. ▶ The limit position is now deleted.

Deleting both limit positions

i Any additional functions that may have been set are deleted at the same time, or are reset to the factory default settings.

		Open/close the shading solution to a point between the limit positions.
		Press the programming button and keep it pressed.
		Then press down the travel button and keep it pressed.
		Now release the programming button, but continue to keep the travel button pressed.
	(M) 2x	Next press the programming button again. <ul style="list-style-type: none"> ▷ The tubular drive confirms. ▶ Both limit positions are deleted.

Setting the limit positions with Auto-install (for ZIP applications with heavy end strip)

For proper execution of the auto-install function, the necessary torque in the lower limit position must be at least 1/3 of the rated torque of the tubular drive used.

Example:



Tubular drive 12 Nm, barrel diameter 85 mm ($r = 0.0425$ m, no part of the shading solution is on the barrel when uncoiled). 1/3 of the rated torque equals 4 Nm; this means a minimum weight requirement of approx. 9.6 kg in the lower limit position (shading solution + end strip) for this barrel.

Calculation:

$$4 \text{ Nm} / 0.0425 \text{ m} = 94 \text{ N}$$

$$94 \text{ N} / 9.81 \text{ ms}^2 = 9.6 \text{ kg}$$

i To set the limit positions with Auto-install, you need the "drive adapter for obstacle detection". If electrical power is removed from the drive during downward movement, the process starts again from the beginning with the new downward movement.

		Open as far as the permanent upper stop. <ul style="list-style-type: none"> ▷ The tubular drive switches off automatically.
	(M) 1x	Run the fabric downwards until the drive switches off automatically and reverses, while keeping the travel button pressed. The drive now moves one revolution upwards and then down to the lower limit position that has been found, where it switches off. Keep pressing the travel button until the drive confirms once, indicating that the lower limit position that has been found has been saved.
		Now move to the upper limit position twice, so that this is also permanently stored.

Obstacle detection (for ZIP applications with heavy end strip)



Caution

Obstacle detection is only active in conjunction with the "drive adapter for obstacle detection".

In addition, please note that the drive must be pushed in to the shaft as far as the band of the thrust ring.

Use of the drive's obstacle detection system as personal protection is not permitted. It has been designed exclusively to protect the sun protection system from being damaged.

If the drive is correctly installed, it switches off when it detects obstructions or fabric faults and tries to run past the obstruction a second time. If this fails, the drive switches off after the third attempt. Approx. 360° from the lower limit position, the drive interrupts operation immediately following the first detection of an obstacle and makes no further attempt to continue.

The total number of attempts to complete a travel that has been started to the respective limit position is limited to 10 (distributed over several obstruction locations).

If reversing is interrupted, a further drive command is only possible in the direction of reversing. Move the fabric without interruption until the tubular drive stops automatically. It is now possible to travel in both directions again.

Activating/deactivating the additional fabric untensioning function with the programming unit



The "to retracted stop" limit position must be set for the fabric untensioning function.

On delivery, the fabric untensioning function is activated. To deactivate it, move to the Retract limit position. Press the programming button for approx. 5 seconds. The drive moves a short distance out of the limit position and back again. The fabric untensioning function is now deactivated.

Repeat the procedure to activate it.

Information for the electrician

Tubular drives with electronic limit switching can be connected in parallel. The maximum switching contact load of the switching equipment (timer, relay control, switch, etc.) must be observed. To operate drives with electronic limit switching, only use switching elements (timers) that are **not** earthed via the drive. The outputs of the switching element must be potential-free in the neutral position.

Use external conductor L1 to control the up and down direction. Other devices or consumers (lamps, relays, etc.) must not be directly connected to the drive connecting cables. For this purpose, the drives and additional devices must be decoupled by relay controls.

When installing the drive, all-pole disconnection from the mains with a contact gap of at least 3 mm per pole must be provided. It is not permitted to continually operate the drives with the mains voltage set to I+/- . This connection configuration is only intended for the time it takes to carry out commissioning using the programming unit.

Attention

Only use mechanically or electrically locked switching elements with a marked zero position! This also applies when drives with electronic and mechanical limit switching are used in the same system. The changeover time for switching the running direction must be at least 0.5 s. The switch and control must not execute simultaneous UP and DOWN commands. Protect the electrical connections from damp.

Once you have finished wiring everything to the control, ALWAYS check the right direction assignment of the drive to the control buttons UP and DOWN, EXTEND and RETRACT.

If the drive is to be operated with devices which contain sources of interference, the electrician must ensure suitable interference suppression for the relevant devices.

Disposal



The crossed-out bin symbol on the product indicates that the device is subject to mandatory disposal separate from household waste. This product must be handed over to a collection point for electrical and electronic equipment at the end of its service life. The packaging material must be disposed of properly.

Maintenance

These drives are maintenance-free.

Technical data dia. 35

Tubular drive	P5-16	P5-20	P5-30	P9-16
Model	S18			
Type	C PSO Z1 SMI			
Rated torque [Nm]	5	5	5	9
Output speed [rpm]	16	20	30	16
Limit switch range	64 revolutions			
Supply voltage	230 V AC / 50 Hz			
Connected load [W]	85	115	115	110
Rated current consumption [A]	0.36	0.47	0.47	0.47
Operating mode	S2 4 min			
Degree of protection	IP 44			
Min. tube inside diameter [mm]	37			
Emission sound pressure level [dB(A)]	≤ 70			

Technical data dia. 45

Tubular drive	R8-17	R12-17	R20-17	R30-17	R40-17
Model	S18				
Type	C PSO Z1 SMI				
Rated torque [Nm]	8	12	20	30	40
Output speed [rpm]	17	17	17	17	17
Limit switch range	64 revolutions				
Supply voltage	230 V AC / 50 Hz				
Connected load [W]	100	110	160	210	260
Rated current consumption [A]	0.45	0.50	0.70	0.90	1.15
Operating mode	S2 4 min				
Degree of protection	IP 44				
Min. tube inside diameter [mm]	47				
Emission sound pressure level [dB(A)]	≤ 70				

What to do if...?

Problem	Remedy
Tubular drive overruns the limit position or does not reach the set limit position.	Repair electrical installation and re-program limit positions.
	Check electrical installation; remove external devices; reset limit positions.
	Stops have broken off or one or several attachments are broken. Repair system; reset tubular drive, then re-program limit positions.
Tubular drive stops arbitrarily; cannot be restarted in the same direction.	Use a more powerful tubular drive.
	Ensure that the sun protection system runs smoothly.
Tubular drive does not run in the right direction.	Tubular drive is overheated. The tubular drive is operational again after a few minutes.
	Tubular drive is faulty (does not work even after standing still for a long period of time). Replace the tubular drive.
	Clear and remove the obstruction and set the drive in the direction required.
	Check the electrical connection.
Tubular drive only runs for approx. 1 second.	Tubular drive is faulty. Replace the tubular drive.
The tubular drive switches off automatically before the first required limit position (lower limit position) is programmed.	Tubular drive has detected a torque increase. Clear and remove the obstruction. Then move past this position to the desired limit position.
When you attempt to set the limit positions using Auto-install, this does not work.	Close to the desired extended limit position and set a point.
The tubular drive does not function correctly in SMI mode.	Check the electrical connection.
In BUS mode, the tubular drive extends the sun protection with retract commands, or retracts the sun protection with extend commands.	Disconnect the tubular drive from the SMI BUS. Delete the limit positions, switch the direction switch to the opposite position and test the direction of travel with the programming unit. Re-program limit positions.

Sample wiring diagram

Controlling one/several drive(s) via a single KNX/SMI actuator

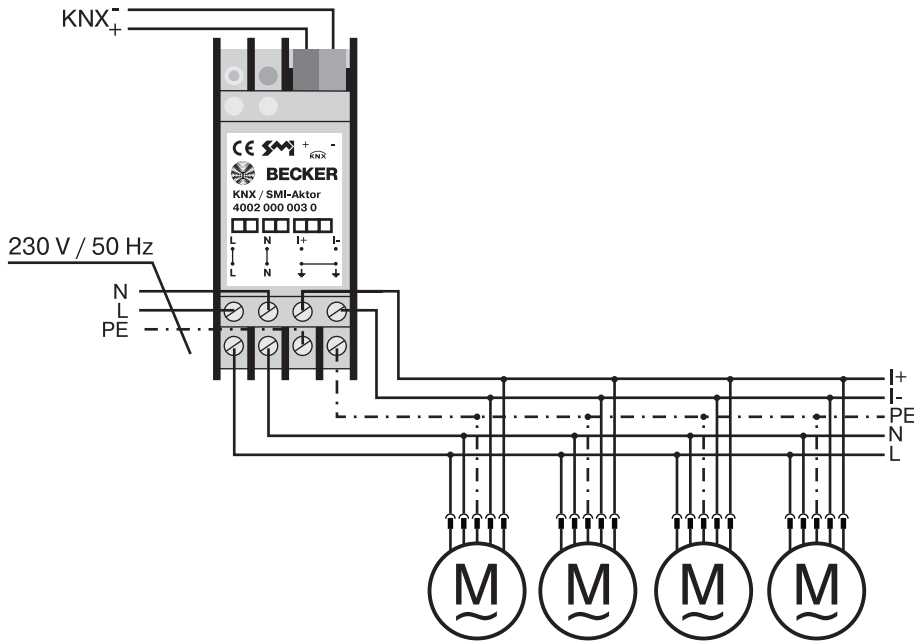

Central control of up to 8 drives possible



Button operation is activated by turning the power supply on and off.

The drive permanently changes to SMI mode as soon as SMI bus voltage is detected on the I+ and I- lines.

Technical information as well as the KNX product database can be found on our homepage www.becker-antriebe.com

Declaration of conformity

BECKER-ANTRIEBE GMBH
Friedrich-Ebert-Str. 2 – 4
35764 Sinn, Germany



BECKER

- Original -

EU Declaration of Conformity

Document No.: **5100 310 005 0**

We hereby declare that the following product series

Product designation: **Tubular motor**

Type designation: **P3/30.., P4/16.., P4/17.., P5/16.., P5/30.., P5/20.., P9/16.., P13/9.., R4/17.., R7/17.., R7/85.., R8/17.., R12/11.., R12/17.., R15/17.., R20/11.., R20/17.., R25/17.., R30/11.., R30/17.., R40/11.., R40/17.., R50/3,5.., R50/11.., L44/14.., L50/11.., L50/17.., L60/11.., L60/17.., L70/17.., L80/11.., L80/17.., L100/11.., L120/11..**

Version: **C, EVO, M, HK, R, S, F, P, E, O, SMI, A0...Z9, mute, +**

From serial number: from **232300001**

complies with the applicable regulations of the following Directives:

Directive 2006/42/EC (MD) L157, 09.06.2006

Directive 2014/30/EU (EMC) L96, 29.03.2014

Directive 2011/65/EU (RoHS) L174, 01.07.2011

Furthermore, the safety objectives of the **Low Voltage Directive 2014/35/EU** as per Appendix I No.1.5.1 of Directive 2006/42/EC have been met.

Applied standards:

DIN EN 60335-1:2020

DIN EN 60335-2-97:2017

EN 61000-6-1:2019

EN 61000-6-3:2022

EN 14202:2004

Authorised party for the compilation of the technical documentation:
Becker-Antriebe GmbH, Friedrich-Ebert-Str. 2 – 4, 35764 Sinn, Germany

This declaration of conformity was issued:

Sinn, 02.06.2023

Place, Date

Maik Wiegemann, Management

This declaration certifies compliance with the Directives cited but does not represent any assurance of characteristics. The safety warnings in the supplied product documentation must be observed!

CE Antriebe M+E_ 5100 310 005 0 _de



BECKER
for you. forever.